

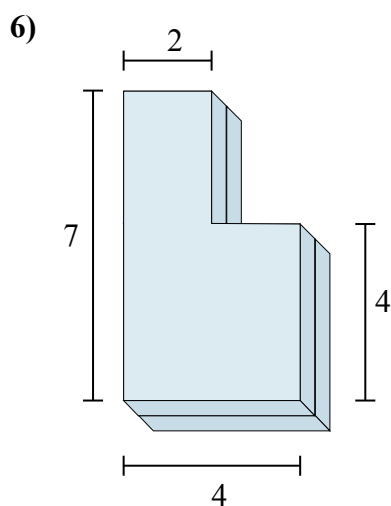

Определите общий объем показанных фигур.

Ответы

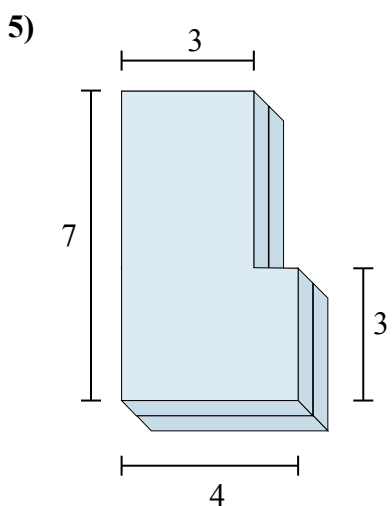
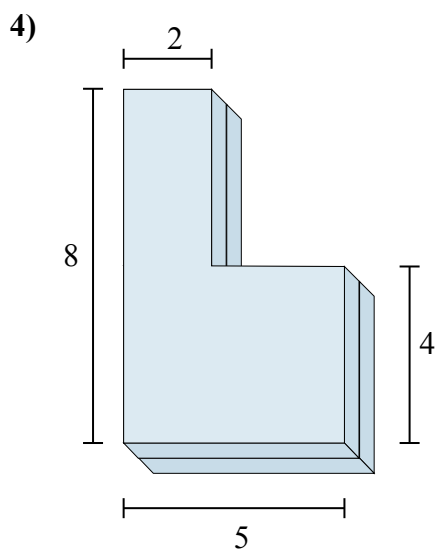
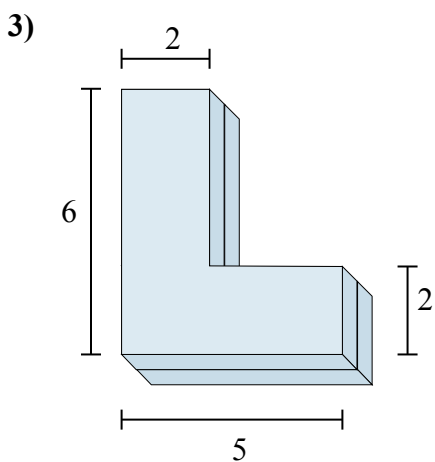
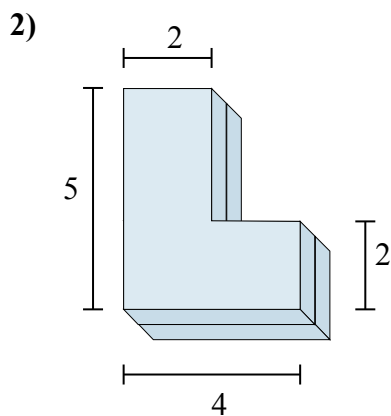
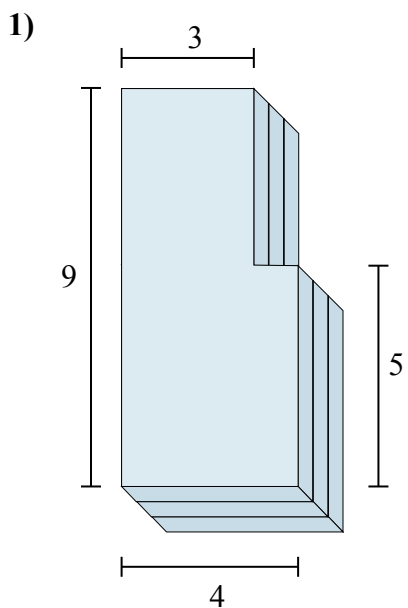

- 1. _____
- 2. _____
- 3. _____
- 4. _____
- 5. _____
- 6. _____

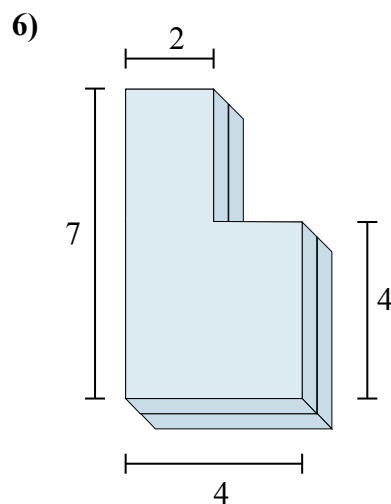
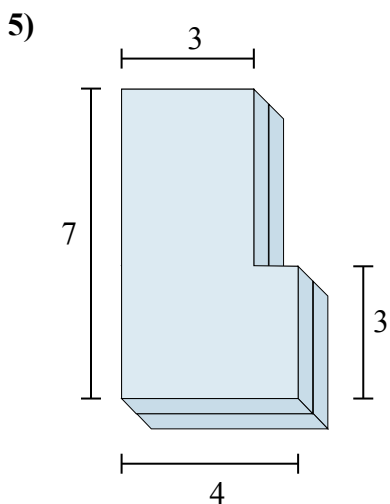
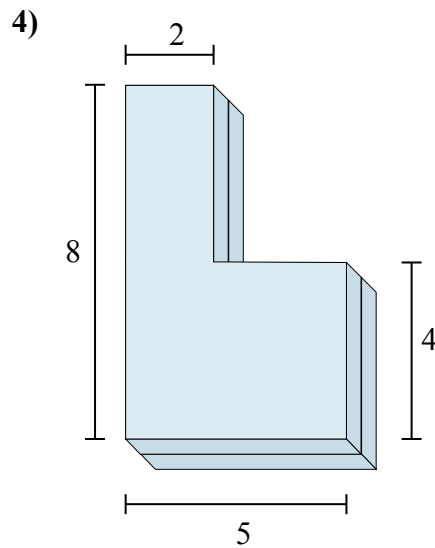
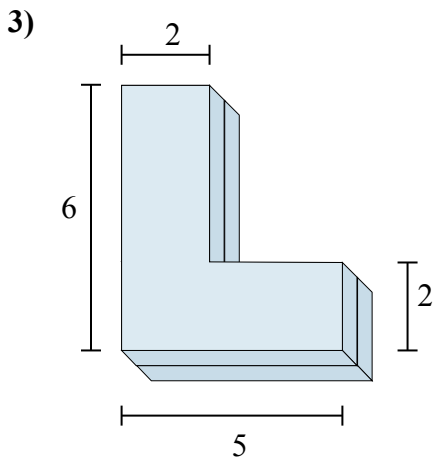
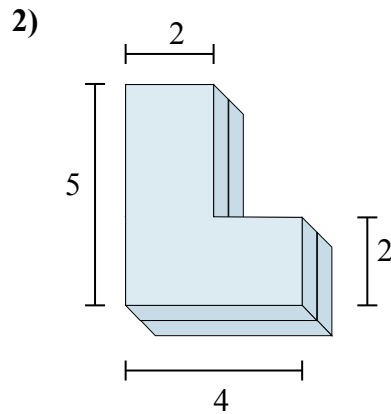
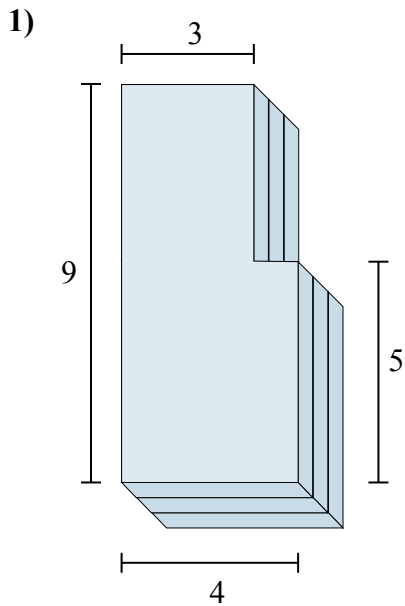

Определите общий объем показанных фигур.

**ОТВЕТЫ**1. **96 cm³**2. **28 cm³**3. **36 cm³**4. **56 cm³**5. **48 cm³**6. **44 cm³**



Определите общий объем показанных фигур.

ОТВЕТЫ

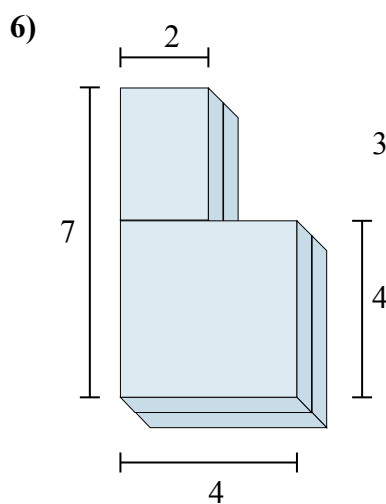
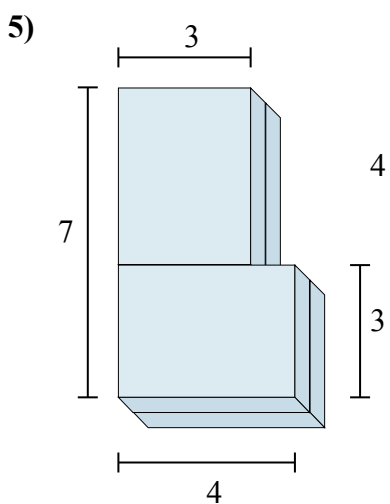
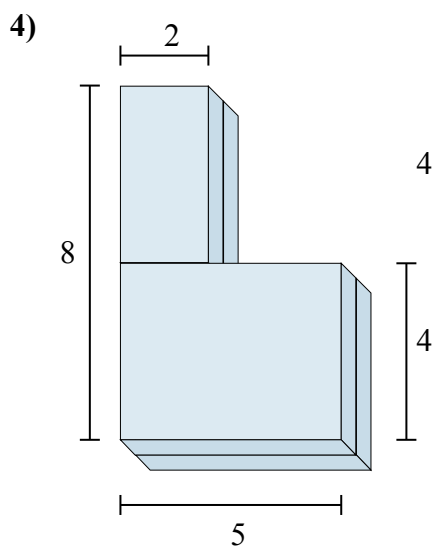
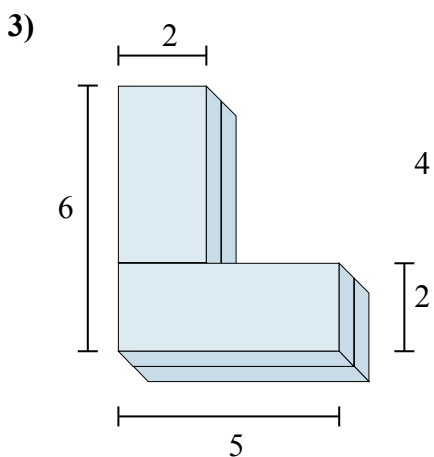
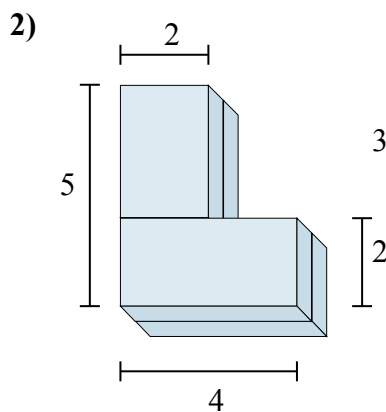
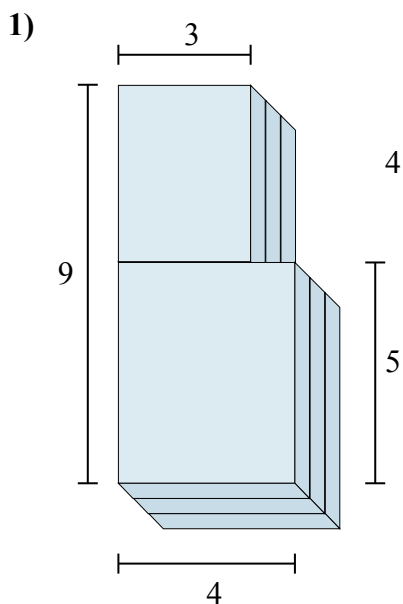

1. _____
2. _____
3. _____
4. _____
5. _____
6. _____