

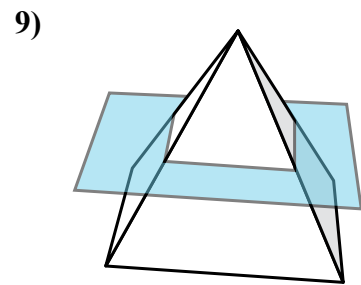

Определите получившуюся 2d фигуру, если 3d фигура будет разрезана как показано.

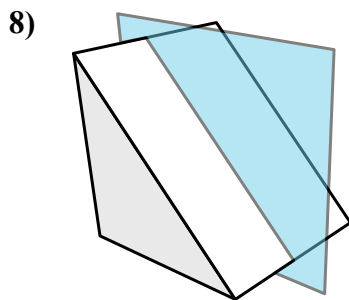

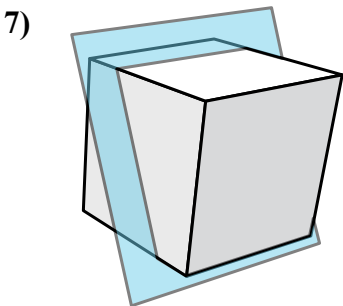
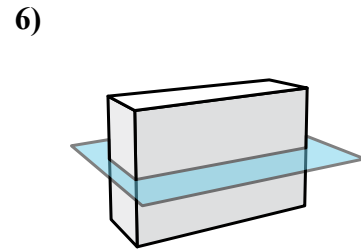
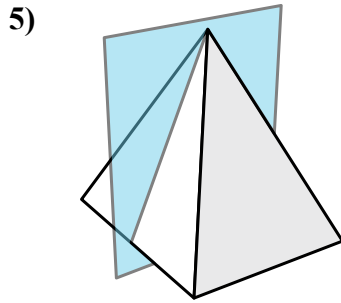
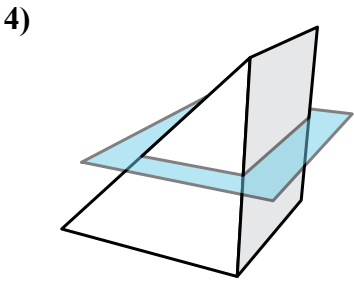
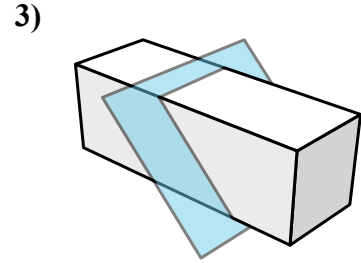
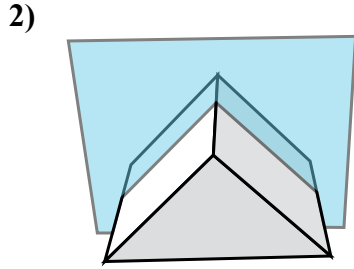
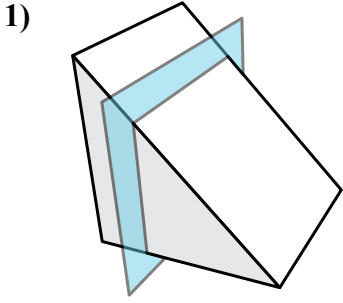

Определите получившуюся 2d фигуру, если 3d фигура будет разрезана как показано.

